

F-2035 (17982)
December, 2009



WARNING

**Protect yourself and others.
Read and understand this booklet.**

Precautions and Safe Practices for GAS WELDING, CUTTING, and HEATING

Be sure this information reaches the operator.

Keep this booklet available for reference at all times.
You can get extra copies through your supplier.

OXWELD® / PUROX® / PREST-O-LITE®



ESAB Welding &
Cutting Products

FOREWORD

The "Occupational Safety and Health Act of 1970" (OSHA) was enacted "to assure safe and healthful working conditions for working men and women...". As duties under Section 5 of this Act, each employer shall:

1. Furnish to each of his employees employment and a place of employment which are free from recognized hazards that are causing or are likely to cause death or serious physical harm to his employees.
2. Comply with occupational safety and health standards promulgated under this act.

Each **employee** shall comply with occupational safety and health standards and all rules, regulations, and orders issued pursuant to this Act which are applicable to his own actions and conduct.

If an employee has language difficulties or cannot be expected to read and understand this booklet, the employer should provide additional training and help to the individual.

This booklet provides safety and health information on oxy-fuel gas welding, cutting, heating, and allied products and processes such as brazing, soldering, and use of air-fuel gas equipment. You should be familiar with the information in this booklet as well as "Safety in Welding and Cutting" - ANSI Z49.1, which is published by the American Welding Society, P. O. Box 351040, Miami, Florida, 33135. Material Safety Data Sheets (MSDS's) on various products, such as welding rods, wires and fluxes, also provide helpful safety and health information.

Read the manufacturers' operating instructions for the apparatus you use. You should be familiar with the proper operation of all equipment before you start to work. ALWAYS READ AND UNDERSTAND THE MANUFACTURER'S OPERATING INSTRUCTIONS AND YOUR EMPLOYER'S SAFETY PRACTICES BEFORE OPERATING AND MAINTAINING GAS WELDING AND CUTTING EQUIPMENT.

-Also-

ALWAYS READ AND UNDERSTAND ALL PRECAUTIONARY LABELS AND INSTRUCTIONS BEFORE USING EQUIPMENT, MATERIALS, OR GASES. A typical precautionary label (tag) for welding materials is shown on Page 3. This booklet provides supplementary precautionary information.

WARNING: Protect yourself and others. Read and understand this tag. FUMES AND GASES can harm your health. HEAT RAYS (INFRARED RADIATION from the flame or hot metal) can injure eyes. NOISE can damage hearing.

- Read and understand the manufacturers' instructions and your employer's safety practices.
- Keep your head out of the fumes. Do not breathe fumes and gases caused by the flame. Use enough ventilation. The type and amount of fumes and gases depend on the equipment and supplies used. Air samples can be used to find out what respiratory protection is needed.
- Wear correct ear, eye, and body protection. • Prevent fires.
- Send equipment in need of repair to maintain UL listing.
- To learn more about SAFETY AND HEALTH read the manufacturers' literature; form 2035 "Precautions and Safe Practices for Gas Welding, Cutting, and Heating"; OSHA Title 29 CFR 1910 from the Govt Printing Office; and American National Standard Z49.1, "Safety In Welding and Cutting" available from the American Welding Society, P.O. Box 351040, Miami, FL 33135.

FIRST AID: IN CASE OF EMERGENCY - Call for medical aid. Employ First Aid techniques recommended by the American Red Cross. IF BREATHING IS DIFFICULT give oxygen. Call a physician. IN CASE OF EYE BURN call a physician.

If Removed, Save This Tag.
Be sure it is read by all users of this product.
FOR INDUSTRY USE ONLY

This booklet is intended for beginners and skilled operators. The Appendix, which discusses the health hazards, is intended for use by persons trained in first aid, as well as medical professionals. It will help you do the best job possible. Additional copies of this booklet (2035) may be obtained from your Sales Representative or Distributor.

For safety and health information covering arc welding and cutting operations, obtain a copy of Form 52-529, "Precautions and Safe Practices for Arc Welding, Cutting and Gouging."

IMPORTANT SAFETY MESSAGE

This Box Contains An Oxygen Regulator That Was Specially Designed For Burnout Containment. Ask Us About It.

PREVENT SERIOUS INJURY



This label is placed on all boxes containing oxygen regulators.
See Page 22 for important details.

TABLE OF CONTENTS

FOREWORD	2
DESCRIPTION OF MAJOR HAZARDS AND PRECAUTIONS	5
Fumes and Gases.....	5
Heat Rays and Spatter.....	7
Noise	8
Prevent Fires.....	9
Welding and Cutting of Containers	10
Oxygen.....	10
Fuel Gases	11
Handling, Storage, and Use of Cylinders.....	12
Manifolded Cylinders and Piping Systems.....	17
Setting Up and Operating Oxy-Fuel Gas Systems	18
Cylinders and Equipment.....	18
Oxygen Regulators	22
Confined Spaces	23
Other Recommended Safe Practices.....	24
MAINTENANCE PRECAUTIONS	26
APPENDIX	28
1. Chemical Substances and Potential Health Hazards in the Welding and Cutting Environment.....	28
RECOMMENDED REFERENCES	37
EMERGENCY AND FIRST AID PROCEDURES	Back Cover

ESAB Welding & Cutting Products
P.O. Box 100545
Florence, SC 29501-0545
(803) 669-4411

DISTRIBUTORS IN PRINCIPAL CITIES

The terms "Oxweld", "Purox", and "Prest-O-Lite" are registered trademarks of ESAB Welding & Cutting Products

Copyright 1994 by ESAB Welding & Cutting Products

DESCRIPTION OF MAJOR HAZARDS AND PRECAUTIONS

FUMES and GASES can harm your health.

Keep your head out of the fumes. Do not breathe fumes and gases caused by the flame. Use proper ventilation. The type and the amount of fumes and gases depend on the type of materials, equipment and supplies used. Air samples can be used to find out what respiratory protection is needed.

1. Provide enough ventilation wherever gas welding, cutting, and heating operations are performed. Proper ventilation will protect the operator from the evolving noxious fumes and gases. The degree and type of ventilation needed will depend on the specific operation. It varies with the size of work area, on the number of operators, and on the types of materials used. Potentially hazardous materials may exist in certain fluxes, coatings, and filler metals. They can be released into the atmosphere during heating, such as for welding and cutting. In some cases, general natural-draft ventilation may be adequate. Other operations may require forced-draft ventilation, local exhaust hoods, booths, personal filter respirators or air-supplied masks. Operations inside tanks, boilers, or other confined spaces require special procedures, such as the use of an air supplied hood or hose mask.

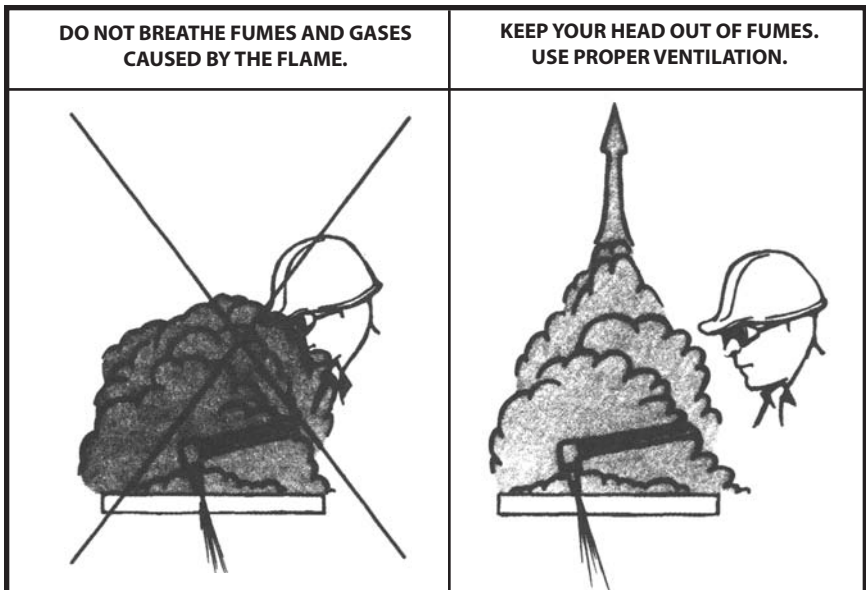

1. Check the atmosphere in the work area and ventilation system if workers develop unusual symptoms or complaints. Measurements may be needed to determine whether adequate ventilation is being provided. A qualified person, such as an industrial hygienist, should survey the operations and environment. Follow their recommendations for improving the ventilation of the work area.
3. Do not weld, cut, or heat dirty plate or plate contaminated with unknown material. The fumes and gases which are formed could be hazardous to your health. Remove all paint and galvanized coatings before beginning. All fumes and gases should be considered as potentially hazardous.

Additional information on various fumes and gases that can harm your health is located in the Appendix of this booklet. Material Safety Data Sheets also provide helpful safety and health information. More complete information on health protection and ventilation recommendations for general welding and cutting can be found in the American National Standard Z49.1, "Safety in Welding and Cutting".

TYPICAL METHODS FOR VENTILATION AND RESPIRATORY PROTECTION

FORCED DRAFT VENTILATION

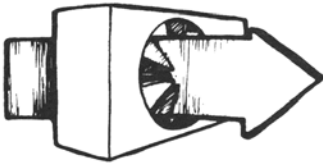

BOOTHS

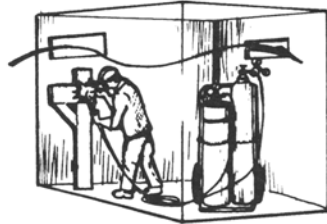

LOCAL EXHAUST HOODS

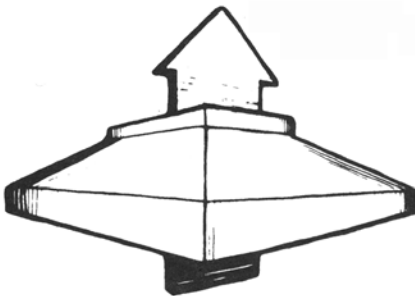

AIR SUPPLIED MASK

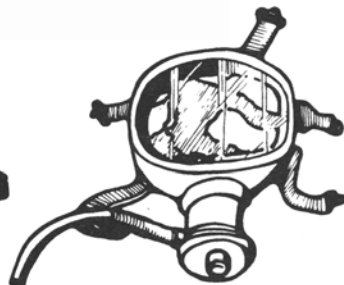

HEAT RAYS (INFRARED RADIATION from the flame or hot metal) and SPATTER can injure eyes and burn skin.

Wear correct eye, ear, and body protection.

Flames and hot metal emit infrared rays. Operators may receive eye and skin burns after over exposure to infrared rays. Long overexposures may cause a severe eye burn. Hot welding spatter can cause painful skin burns and permanent eye damage.

To be sure you are fully protected from the infrared radiation and spatter, follow these precautions:

1. Wear safety goggles made for gas welding and cutting purposes. They will protect your eyes from radiation burns and from sparks or spatter. Use the correct lens shade to prevent eye injury. Choose the correct shade from the table below. Observers should also use proper protection.

FILTER RECOMMENDATIONS (adapted from ANSI Safety Standard Z49.1)

Application	Lens Shade No.*
Brazing	3 or 4
Light Cutting [to 1-in.].....	3 or 4
Medium Cutting [1 to 6-in.]	4 or 5
Heavy Cutting [over 6-in.]	5 or 6
Light Welding [to 1/8-in.]	4 or 5
Medium Welding [1/8 to 1/2-in.]	5 or 6
Heavy Welding [over 1/2-in.]	6 or 8

*As a rule of thumb, start with a shade that is too dark to see the work zone. Then go to a lighter shade which gives sufficient view of the work zone without exerting a strain on your eyes.

2. Protect against eye injury, mechanical injury, or other mishaps. Wear safety glasses with side shields when you are in any work area.
3. Wear clean, fire-resistant, protective clothing. Some operations produce sparks and spatter. Protect all skin areas from sparks or spatter. Avoid spark and spatter traps by wearing a jacket with no pockets, and pants with no cuffs. Sleeves should be rolled down and buttoned. Collars should be buttoned. Wear high, snug fitting safety shoes and gauntlet gloves. Protect your head by wearing a leather cap or hard hat. Wear ear protection where there is a chance of sparks or spatter entering your ears. Do not wear clothing stained with grease and oil. It may burn if ignited by the flames or sparks and spatter. For high heat work, such as heavy cutting, scarfing, or oxygen lance operations, face shields, fire-resistance aprons, leggings, or high boots may be needed. Remove all flammable and readily combustible materials from your pockets, such as matches and cigarette lighters.

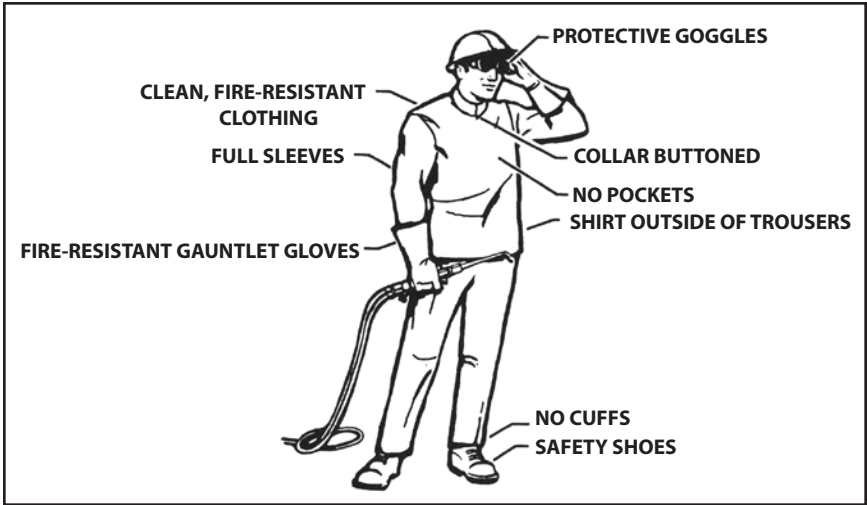

SELECT CLOTHING TO PROVIDE MAXIMUM PROTECTION FROM SPARKS AND HOT METAL

4. Protect neighboring workers. Shield your station with metal or heat resistant shields.

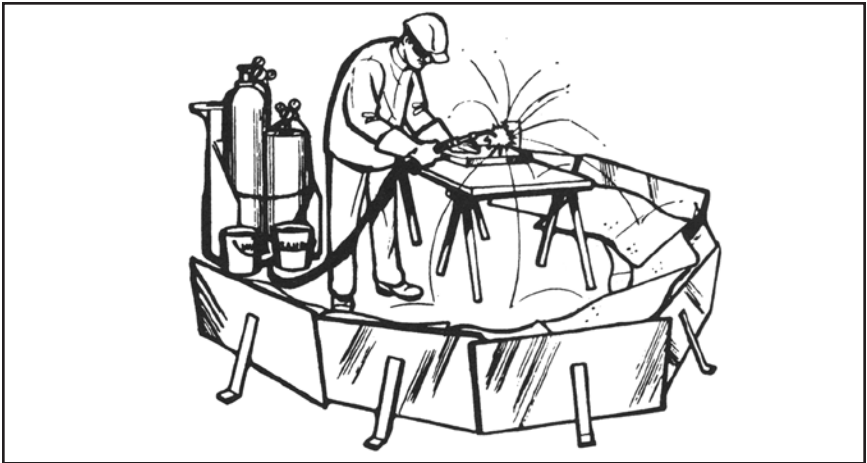

NOISE can damage hearing.

Wear correct ear protection.

Wear ear protective devices or earplugs when heavy cutting, scarfing, or oxygen lancing is being performed, or in noisy work areas. In addition, proper ear protection can prevent hot spatter from entering the ear.

OTHER PRECAUTIONARY MEASURES

PREVENT FIRES.

Flame, hot slag, sparks, and radiant heat act as a source of ignition. Never weld or cut near a potential fire hazard.

Every worker should be familiar with the following fire-prevention and fire-protection measures:

- 1. Maintain a safe workplace.** If possible, move the material to be welded or cut to a safe location designated specifically for welding and cutting.
- 2. Keep fire hazards away.** Areas for welding, cutting, and heating must be kept clear and free of flammable liquids, such as gasoline, paints, and solvents; combustible solids, such as paper, packing materials, and wood; flammable gases, such as acetylene and hydrogen. Avoid welding, cutting, or heating in dusty atmospheres or in atmospheres with combustible vapor/gas present. Locate away from work area or protect oxygen and fuel gas cylinders, hoses, and equipment from exposure to flames, sparks, or hot slag. Flame impingement or accumulation of sparks or slag around cylinders or hoses could melt the fusible plugs or burn through hoses. This can result in ignition of escaping fuel gases.
- 3. Provide fire barriers.** If welding or cutting cannot be performed in a designated location or away from combustible materials, provide metal sheets or fire-resistant screens to prevent heat, sparks, and slag from reaching these materials.
- 4. Be alert for cracks or crevices.** Sparks and slag can travel long distances. They can start a fire at a location not apparent to the operator. Look for holes or openings in the floor, crevices around pipes, and other openings which can hide a smoldering fire. Provide a bucket or pan of water, or sand to catch dripping slag from any cutting operations.
- 5. Provide fire extinguishing equipment.** Be prepared to put out fires. Service-able fire extinguishers, fire hoses, or sand buckets should be on hand. Their use depends on the quantity and type of combustible material which may be present.
- 6. Consider the need for a fire watcher.** Operators may not become aware of a fire starting while welding or cutting. Their vision is seriously hampered by the welding goggles and dark lenses. Depending upon the circumstances of the work location, it may be advisable to have a fire watcher to operate an extinguisher and sound a fire alarm in case of a fire.
- 7. Know the local fire codes for welding and cutting.** Follow the information on fire protection during welding or cutting operations in National Fire Protection Association Standard NFPA No. 51 B, "Standard for Fire Prevention in Use of Cutting and Welding Processes."

- 8. Inspect the work area after completing operations.** Make sure there are no hot sparks or hot metal which could start a fire later.
- 9. Before welding or cutting in a new location for the first time, always check with the nearest foreman or superintendent in authority.** They may know of some serious fire hazard that might otherwise be overlooked.

WELDING AND CUTTING OF CONTAINERS AND PIPING

Containers and piping can explode by heat of welding or cutting unless properly cleaned and vented. Toxic fumes can be formed when welding, cutting or heating metal which has been in contact with an unknown material. Do not weld or cut any material or container unless it has been cleaned by qualified personnel.

The welding or cutting of containers or piping which previously held flammable liquid or an unknown material is extremely dangerous unless they are first properly cleaned. Enough combustible or potentially toxic material may remain to be an explosion, fire, or poison hazard when the material is vaporized by heat from the welding or cutting torch. Ventilating ducts exhausting flammable or toxic gases should be considered as a hazardous container. Make sure surrounding pipelines or containers are protected before striking a flame.

For additional information on welding and cutting containers and piping, refer to AWS F4.1, "Recommended Safe Practices for the Preparation for Welding and Cutting of Containers and Piping That Have Held Hazardous Substances", published by the American Welding Society.

OXYGEN

Oxygen causes fire to burn more rapidly. Anything that burns in air burns violently in oxygen.

- 1. Avoid oxygen regulator fires (ORF). USE NO OIL! Keep regulators, hoses, torches and other oxy-fuel gas equipment free of grease, oil, and other combustibles.** Oil grease, coal dust, and similar combustible materials once ignited burn violently in the presence of oxygen and may cause serious burns or explosions. Never handle oxygen cylinders or equipment in the same areas with grease or oil. The results of an uncontained ORF can be a catastrophic explosion. The explosive burning of materials can cause injury, burns, or death.
- 2. Never use lubricants on oxy-fuel gas equipment.** Connections are designed for seating leak tight without sealants or lubricants.
- 3. Never substitute oxygen for compressed air.** "Oxygen" should never be called "air". Oxygen should never be used in pneumatic tools, in oil preheating burners, to start internal combustion engines, to blow out pipelines, to dust clothing or work, for pressure tests of any kind, or for ventilation. Using oxygen for air may result in serious burns or explosions.

- 4. **Never allow oxygen or oxygen-rich air to saturate your clothing.** A spark might quickly start an engulfing fire and may result in serious burns. Materials that can be ignited in air have lower ignition temperatures in oxygen.

FUEL GASES

Fuel gas can explode in air or oxygen if ignited by a flame, spark, or other ignition source.

Fuel gas can cause rapid suffocation without warning.

Acetylene, natural gas (mainly methane), and liquefied petroleum (LP) gases, such as propane, butane, propylene (FG-2, etc.) and MAPP* are commonly used gases in gas welding, cutting, and heating processes. These gases can displace the oxygen required for normal breathing. An atmosphere with less than 18% oxygen can cause rapid dizziness, unconsciousness, or even death. Therefore, be aware of the following precautions:

1. Make sure a confined area is well ventilated before entering. If there is doubt, check area with an oxygen analyzer to be sure it contains a life supporting atmosphere. Otherwise, wear an air-supplied respirator. A second person, similarly equipped, should be standing by.
2. Do not bring gas cylinders into confined areas.
3. Do not leave gas equipment in confined areas when not in use.
4. Call fuel gases by their proper names — not just “gas.” Fuel gases differ from each other in heat content, flammability limits, handling characteristics, and safe handling requirements. Therefore, be specific when you refer to a particular fuel gas.

The following figures compare the **relative vapor density** of fuel gases with that of air:

Natural Gas	0.55	} LIGHTER than Air
Acetylene	0.91	
Air	1.00	
Propylene	1.42	} HEAVIER than Air
MAPP*	1.48	
Propane	1.56	
Butane	2.05	

It is important to note that acetylene and natural gas being lighter than air will rise in air. They can collect in high places as well as in closed in areas. Be sure to provide enough ventilation to disperse the lighter than air vapors. Propylene, butane, propane, and MAPP being heavier than air may spread to poorly ventilated areas along the floor or beneath equipment. Also, the heavier gases tend to diffuse in air slowly, increasing the hazard of any accumulations. Therefore, forced ventilation and exhaust ducts at floor level may thus be desirable to protect against unexpected release of the heavier fuel gases.

*Registered trademark of Air Reduction Co.

5. Never release fuel gas where it might cause a fire or explosion. Fuel gases should never be released into the air near other welding or cutting work, near sparks or flame caused by other means, nor in confined spaces. Sparks from circuit breakers, thermostats, etc. can also cause ignition. If necessary to release fuel gas, release it outdoors. Choose a place where there is least likely to be a significant hazard, and where the flammable gas will soon dissipate. Keep in mind the density considerations mentioned on Page 11. Fuel Gases should be considered flammable within the following ranges of concentration when mixed with air:

Natural Gas	Between 2.8% and 17%
Acetylene	Between 2.3% and 80%
Propylene	Between 2.0% and 11.1%
Propane	Between 2.1% and 9.5%
Butane	Between 1.9% and 8.5%
MAPP	Between 3.4% and 10.8%
Hydrogen	Between 4.0% and 75%

Such concentrations in air, given a source of ignition, will burn or, if confined, will explode.

6. Never use acetylene at pressures above 15 psi. Using acetylene at pressures in excess of 15 psi gauge pressure (or about 30 psi absolute pressure) is a hazardous practice. To do so is contrary to insurance regulations and is prohibited by law in many places. Free gaseous acetylene, depending upon confinement conditions, is potentially unstable at pressures above 15 psig. Some conditions can cause the acetylene to decompose with explosive violence. Experience indicates 15 psig is generally acceptable as a safe upper pressure limit. The 30 psi absolute pressure limit is intended to prevent unsafe use of acetylene in pressurized chambers such as caissons, underground excavations, and tunnel construction. (Absolute pressure is equal to gauge pressure plus atmospheric pressure, which at sea level averages 14.7 lb. per sq. in. Thus, at sea level, a gauge pressure reading of 15 lb. per sq. in. is equal to an absolute pressure of 29.7 lb. per sq. in.) Note that under no flow conditions some regulators will indicate up to 24 psig on its delivery pressure gauge, but as soon as the gas valve is turned on, the delivery pressure will return to 15 psig or less. This is an acceptable condition.

For more specific safety information on any gas, see your gas supplier.

HANDLING, STORAGE, AND USE OF CYLINDERS

Cylinders, if mishandled, can rupture and violently release gas. Handle all cylinders with care. Misuse can cause injury or death.

Gas cylinders are constructed and maintained in accordance with the regulations of the Federal Department of Transportation (DOT). Gases may be compressed to 2000 to 5600 psig in high pressure cylinders. Liquid oxygen can be as cold as -361°F (-218°C).

If the gas is flammable, an explosion hazard can exist. Sudden rupture of a cylinder, valve, or relief device can injure or kill as well as cause property damage. Therefore, it is essential to understand all of the following precautions.

- 1. Always read the cylinder label.** Cylinders should be clearly labeled with the name of the gas to identify the contents. The cylinder contents may have their own unique hazards. Know and follow the information on the cylinder label. If the cylinder does not bear a gas label, or if the label is not legible, DO NOT USE THE CYLINDER. Do not assume the identity of the gas by the cylinder paint color or other means. Return the cylinder to the gas supplier for gas identification or cylinder replacement.
- 2. Handle, store, and use cylinders in an upright and secured position.** Prevent cylinder damage; secure cylinders by chain or strap to suitable cylinder carts, benches, wall, post, or racks. Never secure cylinders to electrical lines or conduits. If transporting cylinders in vehicles such as pick-up trucks, secure other cargo as well so it cannot roll or slide and damage the cylinders. Transport with the regulator removed, cylinder valve closed, and cap in place. Prevent explosions, never transport cylinders in the trunk of a car or other confined spaces. Do not place cylinders in confined unventilated spaces such as closets, drawers, cabinets, or tool boxes. Always provide plenty of ventilation. Ventilation will prevent the accumulation of hazardous quantities of gas in case of a leak. If stored outside, prevent ice or snow from collecting on cylinders with recessed tops.



3. **Use suitable hand trucks or racks for moving cylinders.** Properly capped, cylinders may be moved for short distances by rolling them on their base. Care must be taken to prevent the cylinder from rolling or sliding out of control. Avoid rough handling. Do not slide or drag cylinders. Do not bump cylinders. Do not allow cylinders to drop or tip over. Do not roll cylinders on a wet floor or steel dock plate.
4. **Never use or transport a leaking cylinder.** If leakage is noted with valve opened or closed, or around safety-relief devices, immediately move the cylinder out-doors, well away from any source of ignition. Notify the supplier immediately for instructions as to further handling of the cylinder and to its return. Before you start welding or cutting operations, leak test the cylinder valve packing gland (see pg. 20, item I I) and all hose and regulator connections. Make sure there are no leaks. Remember, flammable gases can explode.
5. **Unless in use, cylinder valves should be kept closed at all times.** This will prevent accidental release of gas.
6. **When manually lifting cylinders, do not raise them by the valve-protection cap.** The cap may accidentally and suddenly come loose. The cylinder may fall and rupture.
7. **Never use slings or electromagnets for lifting and transporting cylinders.** Use a cradle or suitable platform when transporting them by crane or derrick.
8. **Never tamper with safety-relief devices on gas cylinders.** They are provided to vent the contents to relieve excessive pressure within the cylinders if the cylinders are exposed to fire or excess temperatures. When fuse plugs melt, escaping fuel gases may ignite and cause a fire or explosion.
9. **Never use any gas from a cylinder except through an approved pressure-reducing regulator.** A regulator is designed for reducing the high pressure of the compressed cylinder contents to a constant, controllable working pressure for the equipment in use. A single approved regulator may, however, be connected to the outlet of manifolded cylinders sup

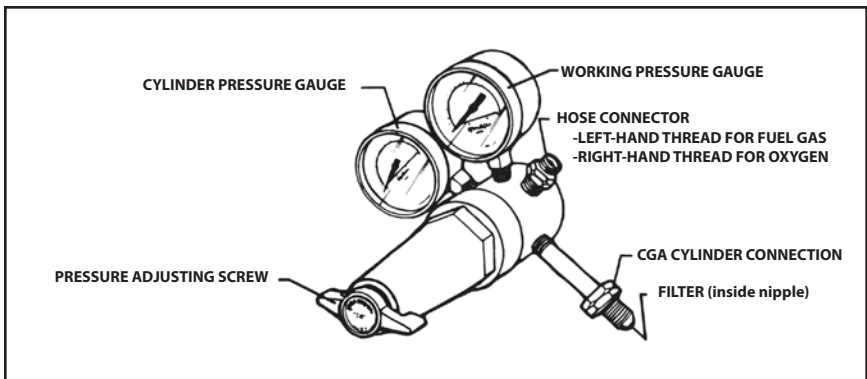

Typical Pressure-Reducing Regulator

plying one or more use points. Pressure-reducing regulators shall be used only for the gas and pressures for which they are intended. Use no adapters. Never interchange regulators between gases. Use the proper gas pressures recommended for the equipment as furnished by the equipment manufacturer. Do not move, transport, or store any cylinder with regulator attached, except on an approved cart.

10. **On cylinders equipped without handwheels, always use the special T-wrench or key for opening and closing acetylene cylinder valves.** Leave the T-wrench or key in position, ready for immediate use, so that the acetylene can be quickly turned off in case of emergency. This will reduce the chance of accidental fires and explosions. If this wrench is lost, obtain a new one without delay from the acetylene supplier.
11. **Do not open an acetylene cylinder valve more than one and one-half turns.** This permits adequate flow of acetylene and allows ready closing of the valve in an emergency situation.

IF NOT EQUIPPED WITH HANDWHEEL, USE THE SPECIAL T-WRENCH TO OPEN ACETYLENE CYLINDER VALVES. DO NOT OPEN VALVE MORE THAN 1-1/2 TURNS.



12. **Should the valve outlet of a cylinder become clogged with ice, thaw with warm — not boiling — water.** Fusible plugs in the valve or cylinder head can melt as low as 1650 F (740 C) on some cylinders. Never use a flame or other heating device for this purpose.
13. **Do not use a hammer, wrench, or pliers for opening and closing cylinder valves equipped with handwheels.** Using force, other than hand, may damage the valve and cause sudden release of pressure. If the valve cannot be readily opened or closed leak tight by hand, immediately notify your supplier to have it exchanged for a new cylinder. Store leaking cylinders outside in a safe place with plenty of ventilation.
14. **Never let the recessed top of a cylinder become filled with water, or be used as a place for tools.** Nothing should interfere with quick closing of the cylinder valve, or possibly damage the fusible plugs or other safety-relief devices in the cylinder head.
15. **Never use any cylinder, full or empty, as a roller or support.** The cylinder walls may be damaged and result in rupture or explosion.
16. **Never transfer any gas from one cylinder to another or attempt to mix any gases in a cylinder.** Any attempt to transfer or mix gases could result in a cylinder rupture or explosion.
17. **Cylinders should not be placed where they might become part of an electrical circuit.** They must never be used as a grounding connection. Accidental arcing could cause a local defect (arc-burn) which could lead to eventual cylinder rupture.

- 18. Store all gas cylinders in a separate, dry, well-ventilated room.** Do not let full or empty cylinders stand around and clutter up work areas. They may interfere with operations, and they may be subjected to damage.
- 19. Full and empty cylinders should be stored separately.** Storage location should be arranged so that the old stock of cylinders can be removed first. Cylinders should not be exposed to continuous dampness nor to grease and oil. They should not be stored near salt water or corrosive chemicals or fumes. Corrosion can weaken the cylinder. This can eventually lead to sudden rupture or explosion.
- 20. Store and use cylinders away from welding and cutting work.** They should not be exposed to falling objects, moving machinery, and vehicular traffic. Storage areas should be located where cylinders will not likely be knocked over. Cylinders should be secured by suitable means such as chains or straps.
- 21. Store cylinders at least 20 feet from any combustible materials.** To prevent rupture due to gas or liquid expansion, the cylinders should not be subjected to temperatures above approximately 125° F (52° C). Flammable-gas cylinder storage areas should be heated by indirect means, and meet the design requirements of National Fire Protection Association NFPA Standard 51 or 58. Smoking, open flames, and other sources of ignition must be prohibited in areas where oxygen and flammable gases are stored.
- NOTE: Refer to the latest NFPA Standards No. 51 and No. 58 for complete information on storage of cylinders and to Compressed Gas Association (CGA) Pamphlet P-1, "Safe Handling of Compressed Gases."*
- 22. Cylinders should be grouped by types of gas.** Where gases of different types are stored at the same location, oxygen cylinders should be separated from flammable-gas cylinders a minimum distance of 20 feet or by a non-combustible barrier at least 5 feet high having a fire-resistance rating of at least 1/2 hour. (Refer to NFPA Standard 51.)
- 23. Cylinders used in public areas or at construction sites should be located where they cannot be tampered with by unauthorized persons.** Store cylinders in accordance with state and local regulations and in accordance with appropriate standards of the Occupational Safety and Health Administration (OSHA).

MANIFOLDED CYLINDERS AND PIPING SYSTEMS

To avoid frequent changing of cylinders or if greater flow capacity is needed, such as with large heating heads or nozzles requiring high flows, two or more cylinders of the same gas may be manifolded and provided with a common outlet for connecting a single approved regulator. Only approved manifolds or connecting components should be used.

Follow the manufacturer's recommendations or check with your fuel gas supplier for the minimum number of cylinders that should be manifolded for a particular high flow application. With acetylene, the recommended withdrawal rate on a continuous basis should not exceed 1/7 of the rated capacity of cylinder. (In other words, withdrawal rate from a 300 cu. ft. cylinder should not be greater than 43 cfh.) Withdrawal rates will differ with other fuel gases. Lack of fuel gas flow can overheat the tip or nozzle and cause a flashback.

Manifolded cylinder gas supply or bulk source of gas may also be distributed through a piping system to multiple station outlets. Such piping systems for oxygen and fuel gas must be designed and installed in compliance with existing NFPA, OSHA, Federal, state, and local regulations.

SETTING UP AND OPERATING OXYGEN-FUEL GAS SYSTEMS

Cylinders and Equipment

Here is a list of steps and important things to check when hooking up cylinders and equipment. They are intended to help prevent possible injury or death to you and your fellow workers. They should also prevent possible equipment and property damage. Even small gas leaks can cause injury or death due to fires, explosions, or asphyxiation.

1. **Fasten the cylinders to be used in an upright position.** If cylinders are not on a suitable cylinder cart, they should be securely chained or strapped to a workbench, wall, or post so that they cannot be accidentally knocked or pulled over. Do not fasten cylinders to electrical lines or conduits.
2. **Be sure to keep a clear space between cylinders and the work.** This is important so that cylinders and pressure-reducing regulators can always be reached quickly. Carefully examine cylinders for defects or oil and grease. Do not use if present.
3. **“Crack” the cylinder valve.** Remove the protective cap from cylinder, if provided. Stand at one side or rear of the cylinder outlet. Open the cylinder valve slightly for an instant, and then close it. This will clean the valve of dust or dirt which may have accumulated during storage. Dirt or other contaminants can damage critical parts of a regulator, and may cause a fire or explosion.

NOTE: Valves on flammable -gas cylinders should NOT be “cracked” near welding or cutting work in progress, or near sparks, flame, or other possible sources of ignition.

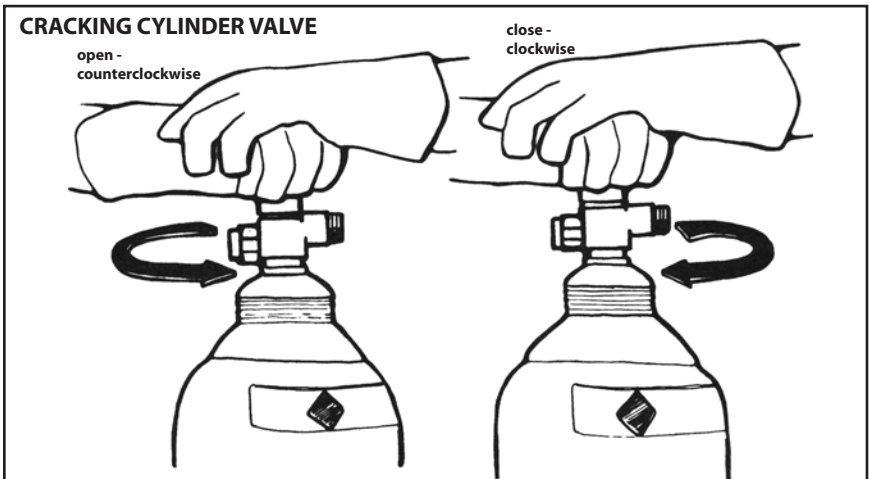

4. **Always attach a regulator to the gas supply.** A pressure-reducing regulator must be connected at the cylinder valve. Make certain that the regulator is proper for the particular gas and service pressure. Make sure the regulator is clean and has a clean filter installed in its inlet nipple. Examine regulator for defects, oil or grease. Do not use if present.
5. **Do not use adapters.** The various Compressed Gas Association (CGA) designated cylinder and hose connections are designed for your protection. Refer to CGA pamphlet V-1 and E-1.
6. **Never force connections that do not fit properly.** This can strip the threads on fittings and result in leaky connections. Do not use lubricants or pipe fitting compound for making connections. To prevent leakage, all seating surfaces should be clean and smooth. Be sure the regulator and hose nuts are pulled up wrench-tight, not merely handtight. Do not tighten the connections excessively. Use a proper regulator wrench. Do not use vise grips or pipe wrench. If the connection still leaks after reasonable torque has been used in tightening the nuts, stop and repair the connection.
7. **Only use hoses fitted with connections made especially for oxygen-fuel gas equipment.** Oxygen hose is usually green with right-hand threaded connections; red hose with left-hand threaded connections (indicated by a groove-about the nut) is used with any fuel gas. They are designed to prevent improper connections between the regulators and the torch. The hoses should be free of oil and grease, in good condition, and free of cuts and heavy abrasions. Support hose out of traffic path so that fork lift trucks and other vehicles do not run over them. Use grade R and RM hose for acetylene. Use grade T for acetylene and other fuel gases.

NOTE: New hoses may contain some loose talc resulting from the manufacturing process. The talc should be blown out of both oxygen and gas hoses using about 5 psi of oxygen for a few seconds. Do not use compressed air or fuel gas for this purpose. After blowing out the fuel gas hose with oxygen, purge the hose of concentrated oxygen by blowing from your mouth or using dry nitrogen.

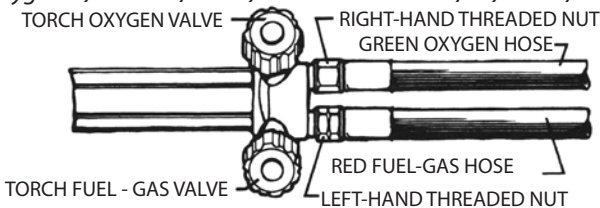

8. **Before opening a cylinder valve, make sure the regulator pressure-adjusting screw is released by rotating it counterclockwise until it turns freely.** This closes the regulator valve and prevents a sudden surge of pressure from possibly damaging components in the system, or causing an oxygen regulator fire.

- 9. While opening a cylinder valve, stand to one side of the regulator.** Do not stand in line with the front or back of the pressure-adjusting screw or gauges. **SLOWLY** open the cylinder valve. **NEVER** open a cylinder valve suddenly. A sudden surge of high pressure gas can weaken or damage critical components in the regulator, or even cause an oxygen regulator fire. Do not open the acetylene cylinder valve more than 1-1/2 turns. Leave the T-wrench in place.

BACK OUT PRESSURE ADJUSTING SCREW. SLOWLY OPEN CYLINDER VALVE....

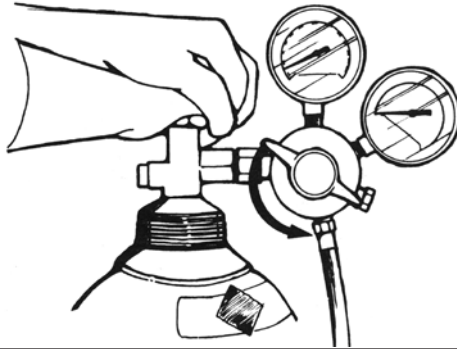

- 10. Always make sure there is enough oxygen and fuel gas available in the cylinders to complete your welding, cutting, or heating work.** If you run out of one gas while operating and you must change cylinders, it is imperative that the hose lines be thoroughly purged, for several seconds at least, before an attempt is made to relight the torch. Never allow the oxygen cylinder pressure to fall below 100-125 psig. Start again with step 8 when replacing cylinders.

NOTE: Reverse flow check valves are available for mounting on torch hose connections. They are designed to provide a certain amount of protection against the back flow of one gas into the hose of the other in the event of sudden loss of pressure of the one gas. These check valves are designed to prevent a reverse flow of gas. They are NOT designed for stopping flashbacks. Careless use, abuse or accumulated dirt can shorten check valve service considerably. They should be checked regularly for back flow leakage, as directed by the valve manufacturer. Check valves will restrict flow and should not be used with large heating heads.

- 11. Check all connections and joints for leaks.** After making all connections, close the torch or downstream valve. Then, turn in (clockwise) the regulator pressure-adjusting screw to the desired operating pressure. Using a suitable leak test solution, check every connection and joint from the cylinder to the torch. Correct any leakage before starting operation. Do NOT use any equipment in need of repair. Do NOT check for leaks with a flame. Leak test one gas line at a time to prevent backflow into the hose lines.

- 12. Never tighten a leaky connection between a regulator and cylinder when under pressure.** Close the cylinder valve; allow the trapped gas to leak out; and then tighten the connection.
- 13. Attach the proper welding tip or cutting nozzle and use correct pressures.** Always be sure you are using the correct gas pressure as recommended by manufacturer. If operating properly, the regulator maintains the pressure as set. The required pressure will vary according to the type of equipment. If reverse flow check valves are used, add enough pressure to make up for pressure drop through check valve.
- 14. Do not use matches for lighting torches.** Hand burns may result from this practice. Use friction lighters, stationary pilot flames, or some other similar source of ignition.



- 15. If the flame goes out and burns back within the torch, producing a pronounced hissing or squealing noise, IMMEDIATELY shut off the torch; otherwise, the flame will burn through the torch and may cause injury.** This is commonly called “flashback”. It indicates a malfunction or incorrect operation of the torch. Flashback should not be confused with “backfire” in which a flame may go out with a loud snap or pop. After a backfire a torch can be relit immediately. A backfire may be caused by touching the tip or nozzle to work, an overheated tip or nozzle, a loosely connected tip or nozzle, dirt on the seat, but most likely by incorrect operating pressures. After a flashback, allow the torch to cool and recheck the operating pressures. Before relighting, allow oxygen (NOT fuel gas) to flow through the torch for several seconds to clear out soot that may have accumulated in the torch. If another flashback occurs or the torch repetitively backfires, remove torch from service. Send the torch along with tip or nozzle in use to an authorized repair station.
- 16. Do not relight on hot work in a pocket or small confined space.** Always relight with a friction lighter. In relighting a flame from hot metal, the gases do not always ignite instantly, and, if in a small pocket, ignition may be violent if it is delayed for even a second.

17. As soon as you have finished working, or if you are going to disconnect the regulator, do the following for each gas but one gas at a time:
 - a. Close the cylinder valve.
 - b. Open the torch valve to release all pressure from the hose and regulator.
 - c. When the inlet gauge pressure drops to zero, turn out (counterclockwise) the pressure-adjusting screw.
 - d. Check inlet gauge to make sure the cylinder is shut off.

This will prevent the release of gas and a possible accident caused by someone removing the regulator with the cylinder valve open.

Oxygen Regulators

There are many different types of oxygen regulators. They are designed to reduce the high pressure of the oxygen coming from the cylinder to the proper pressure needed for cutting and welding. Oxygen regulators can be damaged, and even burnout with explosive forces that can destroy the regulator when used improperly. Oxygen regulator fires (ORF) can violently release the full cylinder pressure and contents. This release of contents and the accompanying oxygen enriched fire can cause injury or death to you and your fellow workers, as well as damage to equipment and property. Here is an additional list of important steps to follow. They will minimize the chance of damage from the effects of an ORF.

1. **We strongly recommend the use of oxygen regulators which have been designed to contain Oxygen Regulator Fires for all cylinder service.** Our TRIMLINE oxygen regulators and the R-27 Series and R-22 Series oxygen regulators with ORF protection baffles incorporate these patented design features. In fact, ALL cylinder oxygen regulators currently produced by ESAB incorporate ORF protection devices.
2. **“Crack” the oxygen cylinder valve before attaching the regulator.** Stand to one side or the rear of the cylinder outlet. Open the cylinder valve slightly for an instant, and then close it. This will clean the valve of dust and dirt which may have accumulated during storage. Dirt can damage an oxygen regulator and may cause an ORF.
3. **Use only regulators designed for oxygen service with oxygen.** A pressure reducing regulator must be connected to the oxygen cylinder valve. Make certain the regulator is properly rated for the service pressure. Before installation make sure the regulator is clean, free of grease and oil, and has a clean filter installed in its inlet nipple. Oil, grease, coal dust and other combustibles can cause regulator fires. Never use an oxygen regulator for other gases. Never connect a regulator that has been in non-oxygen service to oxygen service.
4. **Before opening an oxygen cylinder valve make sure the oxygen regulator pressure-adjusting screw is released.** This is done by rotating the screw counterclockwise until it turns freely. This closes the regulator valve and prevents damage due to a sudden pressure surge.

5. **While opening the oxygen cylinder valve, stand by the cylinder valve side of the oxygen regulator.** Never stand facing the pressure adjusting screw or pressure gauges of the regulator while opening the cylinder valve. Open the cylinder valves as SLOWLY as possible, until the high pressure gauge reaches cylinder pressure. Never open a cylinder valve suddenly. Sudden surges of high pressure can cause an oxygen regulator fire.

CONFINED SPACES

1. Introduction/Definition

Many different places require welding, cutting, and heating work. Some of these places lack room and become “confined spaces.” Confined spaces have the following characteristics:

- Limited space, entry, or exit.
- Poor ventilation - lack of safe breathing air possible buildup of hazardous gases, fumes, and particles.

2. Examples of Confined Spaces

- | | | |
|-------------------|-----------------|-------------------|
| • Small rooms | • Unventilated | • Degreasers |
| • Process vessels | corners of a | • Boilers |
| • Pits | room | • Compartments of |
| • Tunnels | • Furnaces | ships |
| • Vats | • Storage tanks | • Ventilation and |
| • Reactor vessels | • Pipelines | exhaust ducts |
| • Underground | • Sewers | |
| utility vaults | • Silos | |

3. Reasons For Deaths and Serious Injuries From Welding In Confined Spaces

- | | |
|-------------|--|
| • Fire | • Exposure to hazardous air contaminants |
| • Explosion | • Electric shock |
| | • Asphyxiation |

4. Actions Required Before Approving Start of Work In A Confined Space

- Open all covers and secure them from closing
- Test confined space atmosphere for
 - (1) suitable oxygen content,
 - (2) no combustibles or reactives,
 - (3) no toxics.

Note: The testing requires special equipment and training.

- Isolate lines by capping or double valving and venting, if feasible-keep vents open and valves lead-free.
- Lock out all systems not required during welding, cutting or heating. Provide means for readily turning off power, gas and other supplies from outside the confined space.
- Protect or remove any hazardous materials or materials which may become a physical or health risk when heated or exposed to an arc.

5. Required Actions During Work In A Confined Space

Continuously ventilate and monitor confined space to ensure that fumes and gases do not exceed safe exposure limits as found in OSHA (Occupational Safety and Health Administration) regulations • Title 29. CFR Part 1910,1000.

- Use NIOSH/MSHA (National Institute for Occupational Safety and Health/ Mine Safety and Health Administration) approved breathing device when required by code, instruction, or good practice.
- Keep unnecessary persons and equipment out of and away from the confined space.
- Do not allow equipment to block exit or possible rescue efforts.
- Place as much equipment as possible outside the confined space.
- Do not go into a confined space unless a watchperson, properly equipped and trained for rescue, is outside and maintaining continuous communications with worker inside.
- Provide means for turning off power, gases, and fuel from inside the confined space, if feasible, especially if outside turn-off means are not provided, feasible, or certain.

6. Information Sources

National Institute for Occupational Safety and Health. Criteria For A Recommended Standard - Working In Confined Spaces, NIOSH Publication No. 80-106. Cincinnati, Ohio: National Institute for Occupational Safety and Health.

Occupational Safety and Health Administration. Code Of Federal Regulations, Title 29 Labor, Chapter XVII, Part 1910. Washington, DC: U.S. Government Printing Office.

De Reamer, R. Modern Safety And Health Technology, New York, New York: John Wiley & Sons.

American National Standards Institute. Safety Requirements For Working In Tanks And Other Confined spaces, ANSI Z117.1-1977. New York: American National Standards Institute.

Mine Safety And Health Administration (MSHA). Code Of Federal Regulations, Title 30 Mineral Resources. Washington, DC: U.S. Government Printing Office.

OTHER RECOMMENDED SAFE PRACTICES

1. Make sure that jacketed containers or other hollow parts are sufficiently vented before heating, welding or cutting. Air, gas, or liquid which is confined inside of a hollow part will expand greatly when heated. The internal pressure created may cause violent rupture of the part. A metal part which is suspiciously light is probably hollow and should be drilled to vent it before heating. Every possible precaution should be taken with jacketed vessels, tanks or containers to vent them sufficiently before doing any hot work.



JACKETED CONTAINERS OR OTHER HOLLOW PARTS SHOULD BE VENTED BEFORE WELDING. THE VENT HOLE CAN BE TAPPED AND PLUGGED AFTER WELDING WORK IS COMPLETED.

2. Do not drop stub ends of welding rods on the floor. Put them in a suitable container. Aside from the fire hazard created by carelessly dropped stub ends, a serious fall might result from stepping on them. A container partly filled with water and within easy reach is a good place to dispose of these short ends.
3. Bushings in castings should be either removed or securely fastened in place before heating the casting. Bronze bushings expand more than cast iron when heated. Besides the possibility of damaging the bushing if left in place, the greater expansion may cause it to fly out, unexpectedly. If the bushing cannot be removed, it should be securely fastened in place. Bolting large washers or pieces of plate over the ends of the bushing is a suitable method.

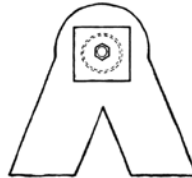
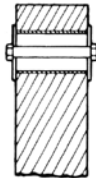

IF BRONZE BUSHINGS CANNOT BE REMOVED,
THEY SHOULD BE SECURELY FASTENED IN PLACE

4. Tips and torches are precision tools. Do not use them as hammers. Damage to the equipment can cause flashbacks, backfires, or gas leaks.
5. Do not cut over bare concrete. Concrete can spall with explosive violence from the heat of the flame or slag.

MAINTENANCE PRECAUTIONS

Faulty or improperly maintained equipment can cause property damage, physical injury, or possibly death by fire or explosion. Here is a list of some important guidelines to follow when maintaining equipment.

1. **Stop operating IMMEDIATELY if equipment is malfunctioning.** Notify your supervisor of the malfunction. Do not perform any further operations until the problem is corrected.
2. **Do not perform any equipment maintenance unless you are qualified to perform such work.** Only qualified personnel should install, maintain, and repair the equipment only in accordance with manufacturer's maintenance instructions and use only genuine repair parts. This is necessary to comply with Underwriters Laboratories (UL) requirements.
3. **Maintain regulators, torches, and hoses in safe working order.** Do not operate equipment in faulty condition. The following should be checked or noted often:
 - a. Regulators must have a clean filter (usually sintered bronze material) installed in the nipple of the cylinder (inlet) connection.
 - b. Regulators should not "creep" (indicated by delivery pressure rising slowly when torch valve is closed) nor leak from any joints. Creeping delivery pressure indicates leakage past the regulator valve seat.
 - c. If metal-to-metal seating surfaces of torch heads, valve stems, or hose connections are causing leakage, send the equipment to your distributor or to the manufacturer for reseating or replacement.
 - d. Replace valve stems if leakage cannot be stopped by tightening the packing nut.
 - e. Maintain clean orifices of welding tips, cutting nozzles, and torch or head mixer assemblies. Clogged orifices may cause flashbacks. Soot, particularly after a flashback, may collect on torch mixer assemblies. Use proper tip cleaning tools or procedures as recommended by the manufacturer.
 - f. Periodically immerse pressurized hoses in water and check for leaks. Do not repair hoses with tape. Damaged nuts and nipples can be replaced using appropriate clamps (automotive clamps are not appropriate) or ferrules. Damaged sections of a hose should be removed and discarded, and then the good sections can be assembled with proper hose splice and clamps. (No more than one splice per 25-ft. length of hose.) Check with your equipment supplier for additional information.
 - g. If hose was burnt internally due to a flashback, or damaged extensively from sparks, slag, abuse, etc., discard the entire hose.

4. Do not abuse the equipment. Protect the equipment from heat, excessive wet conditions, oil or grease, corrosive atmospheres, and inclement weather.

5. Replace parts only with manufacturer's recommended replacement parts.

The equipment is designed to work safely and effectively. Do not substitute, modify, or use unauthorized parts. Use of the wrong part may cause the equipment to fail, regulators to bum out, or gases to leak. Read and understand the operating instructions provided by the manufacturer of the equipment before attempting to repair. Repairs or replacement of parts not covered by the instructions should be performed by an authorized repair station of the equipment manufacturer or distributor. Appropriate literature may be obtained from your distributor.

The notice shown below may appear on the apparatus that you purchased. Please follow instructions to maintain UL listing.

IMPORTANT NOTICE TO USERS

OSHA REGULATIONS STATE THAT ALL WELDING, CUTTING AND BRAZING APPARATUS MUST BE APPROVED OR LISTED BY A NATIONALLY RECOGNIZED TESTING LABORATORY. (SEE 29CFR1910 SUBPART O).

This torch or cutting attachment has been extensively tested with its nozzles/heads and earned the Underwriter's Laboratories (UL) listing. This UL listing is not valid if the torch or cutting attachment is used with nozzles/heads produced by other than original manufacturer.

I. CHEMICAL SUBSTANCES AND POTENTIAL HEALTH HAZARDS IN THE GAS WELDING, CUTTING AND HEATING ENVIRONMENT.

INTRODUCTION

The information in this appendix is directed toward the health and medical professional. It is intended to instruct, as well as alert, the health and medical professional about potential health hazards in the gas welding, cutting, and heating environment.

When gas welding and cutting equipment is used as recommended and according to recognized and accepted sound industrial hygiene standards, as set forth in OSHA regulations and in American National Standard 249.1 "Safety in Welding and Cutting", minimal or no adverse health effects should be expected.

Fumes, gases, flame radiation, and noise are created as by-products of most welding, cutting, and heating processes. The type of process, in itself, is a major factor in determining the concentration of metal fumes and gases, and the intensity of flame radiation which may be produced. The composition of the fumes is dependent on the alloy being welded and the process and rods used. The health hazard potential depends on the concentration and toxicity of the materials involved (types of metals, fluxes, coatings, etc.), length of exposure, the relationship of the welder's head with respect to the fumes, and the effectiveness of control measures, such as ventilation and personal protective equipment.

Table 1 lists some common chemical and physical agents which may be produced as by products in some welding and cutting applications.

DESCRIPTION OF MAJOR HEALTH HAZARDS

1. Respiratory System

Acute — Gases, fumes, and dusts may cause irritation to the eyes, lungs, nose, and throat. Some toxic gases associated with welding may cause pulmonary edema (accumulation of fluid in the air spaces of the lungs), asphyxiation, and death. Acute overexposure may include signs and symptoms such as watery eyes, nose and throat irritation, headache, dizziness, difficulty breathing, frequent coughing, or chest pains.

Chronic — Protracted inhalation of air contaminants may lead to their accumulation in the lungs, a condition which may be seen as dense areas on chest x-rays. The severity of change is proportional to the length of exposure. The changes seen are not necessarily associated with symptoms or signs of reduced lung function or disease. In addition, the changes on x-rays may be caused by non-work related factors such as smoking, etc.

Table 1 - Common Chemical and Physical Agents Which May be Produced as By-products in Some Gas Welding and Cutting Operations.

Fumes* and Gases		Radiant Energy
Aluminum	Carbon Dioxide	Ultraviolet
Beryllium	Carbon Monoxide	Visible
Cadmium	Nitrogen Oxides	Infrared
Chromium	Ozone	
Copper	Phosgene	
Fluorides		
Iron		
Lead		Other Agents
Magnesium		
Manganese		Electricity
Nickel		Noise
Silica		Heat
Silicate		Asphyxiants
Titanium		Flames
Vanadium		
Zinc		

* Including the metals and their oxides. Some of the fumes and gases listed are covered in detail on pages 29 through 31.

2. Eye

Eye injury may be caused by flying particles and flame radiation. Infrared radiation is emitted by flames and hot parts. Infrared radiation penetrates the interior of the eye and can cause burns on the retina. Contact lenses should not be worn while welding or cutting.

3. Skin

Exposed skin is susceptible to cuts, scrapes and burns (electrical and thermal). Skin contact with certain metal dusts, such as chromium and nickel, may cause a dermatitis characterized by dry, red, cracked itchy skin on the hands, forearms, and face. Passage of an electrical current into living tissues may cause electrical burns or fatal shock. Clinical manifestations usually depend on the amount of current that passes through the body. Respiratory paralysis or ventricular fibrillation, or both, may result.

4. Cardiovascular Disease

Carbon monoxide may be generated in operations in which a flame touches a surface that is cooler than the ignition temperature of the gaseous part of the flame. It combines avidly with hemoglobin, reducing the oxygen-carrying capacity of the blood. Exposure to carbon monoxide may present an added health risk to workers with heart disease.

5. Noise

Exposure to high noise levels for long periods of time may result in hearing loss. Exposed workers should wear properly fitted ear protection.

6. Carcinogenicity

Carcinogenicity depends upon many factors, including the properties of the materials of exposure, the adequacy of protective equipment used, the individual's susceptibility, and other factors. Certain metals, such as some chromium VI compounds and nickel, have been reported to cause cancer. The possible con-founding roles of cigarette smoking, environmental agents, and other non-work related factors must be considered.

7. Other Factors

In addition to any direct effects, heat and stress also increase the workers susceptibility to the effects of other agents. Frequent physical examinations are recommended.

COMMON CHEMICAL SUBSTANCES AND THEIR POTENTIAL HEALTH HAZARDS

The following are brief descriptions of materials which may be found in some welding and cutting operations:

Acetylene and other Fuel Gases — Acetylene, propylene (FG-2), propane and butane at very high concentrations are simple asphyxiants, irritants, or anesthetics. Thus, depending on the concentration and exposure time, symptoms such as irritation to the mucous membranes of the eyes, nose, throat and respiratory tract; shortness of breath with rapid respiration; fatigue, dizziness, diminished mental alertness, and muscular incoordination, nausea, vomiting, loss of consciousness, convulsions, and finally coma and death may occur.

Beryllium — Beryllium and its compounds are highly toxic. They can cause serious injury or death. Exposure is capable of producing chronic lung changes which are permanent in nature.

Cadmium — Cadmium fumes or fine dust are capable of causing serious injury or death when inhaled. It is easy to mistake cadmium-plated steel for galvanized steel. However, when heated, cadmium leaves an olive-drab color as it oxidizes. Always know the metal you are working with. Cadmium oxide fumes often cause no symptoms until a few hours after exposure.

Carbon Monoxide — Carbon monoxide may cause illness or death. It is an odor-less, colorless, and toxic gas. Exposure to low concentrations of carbon monoxide may cause headache, metal dullness, and generalized fatigue. The toxic effects of carbon monoxide are similar to those of oxygen deficiency. Loss of consciousness occurs at only very high concentrations.

Chromium — Acute exposure to chromium dust or fumes may cause coughing and wheezing, headache, shortness of breath, pain on deep breathing, and fever.

Other symptoms may include irritation of the conjunctivae of the eye, nasal itch and soreness, ulceration and perforation of the nasal septum, chronic bronchitis, and discoloration of the skin. Certain forms of chromium (VI) have been found to cause increased respiratory cancer among workers.

Copper — The fumes and dust cause irritation of the upper respiratory tract, metallic taste in the mouth, nausea, metal fume fever, and in some instances, discoloration of the skin and hair. Copper dust can act as an irritant to skin causing itching, redness, and dermatitis. It may also cause conjunctivitis and small ulcers of the cornea.

Fluorides — Fluoride fumes can be very irritating to eyes, nose, and throat. Some Fluorine compounds can cause death. Fluorides may be formed when welding with fluoride containing rods, and with some fluxes.

Iron Oxide — Inhalation of these fumes and dust may cause “metal fume fever” (an influenza-like illness lasting 24 to 48 hours), and may also cause a benign pneumoconiosis (siderosis). Pure iron oxide probably does not cause fibrotic pulmonary changes, whereas inhalation of iron oxide plus certain other substances may cause lung injury.

Lead — Lead fumes or fine dust, when inhaled, can cause lead poisoning, anemia, muscle weakness, nausea, vomiting, colic, or death. Be careful to guard against lead poisoning when welding or cutting materials such as lead-coated containers and metals which have been painted. In all such cases, lead produces toxic fumes.

Manganese — Manganese dust and fumes are irritants to the eye and mucous membranes of the respiratory tract. Early recognition of chronic manganese poisoning is difficult. Progression of disease manifestations can vary widely among individuals. Signs and symptoms may include apathy, irritability, loss of appetite, headache, weakness of the muscles in the legs, and joint aches. Speech disturbances are common. Chronic manganese poisoning, although disabling, is usually not fatal.

Nickel — Skin sensitization or “nickel itch” is a commonly seen toxic reaction to nickel dusts. Nickel dust and fumes may also irritate the conjunctivae of the eye and the mucous membranes of the upper respiratory tract. Nickel and its compounds have been reported to produce an increased incidence of cancer of the lung and nasal passages.

Nitrogen Oxides — Nitrogen oxides may irritate the eyes and mucous membranes. High concentrations may produce severe pulmonary irritation and methemoglobinemia. Acute exposure to high concentrations may produce immediate fatigue, cyanosis (“blue lips and skin”), cough, shortness of breath, chills, fever, head-ache, nausea, and vomiting. Collapse and death may occur if the exposure is sufficiently high. Survivors may develop severe and increasing shortness of breath due to chronic lung disease.

Oxygen — Oxygen toxicity occurs in persons exposed to high concentrations of oxygen for an extended period of time and may include the following signs and symptoms: nausea, dizziness, muscular twitching, irritability, chest pain, numbness, and visual disturbances.

Ozone — Ozone is a form of gaseous oxygen. It is produced around every electric arc, particularly when welding aluminum. It has a noticeable odor and exposure may produce irritations of the eyes, nose, and throat. Overexposure may cause death.

Phosgene — This highly toxic gas is formed when the ultraviolet rays from an electric arc contact chlorinated solvents, such as trichloroethylene. Material or equipment which has been degreased by chlorinated solvents should not be welded or cut until it has been thoroughly dried to remove the solvent. Welding or cutting should not be done near degreasing tanks containing chlorinated solvents. To avoid the formation of this hazardous gas, solvents should be stored and used in a separate room from welding operations. Do not leave chlorinated solvents lying around in open buckets or tanks. Keep solvent containers tightly covered when they are not in use. Inhalation of high concentrations of phosgene may produce pulmonary edema frequently preceded by a latent period of several hours' duration. Death may result from respiratory or cardiac arrest.

Silica — The crystalline forms of silica are responsible for producing silicosis. However, attempts to locate crystalline phases of silica in welding fumes have so far been unsuccessful.

Zinc — Do not inhale fumes from welding or cutting galvanized sheet, brass, or other zinc alloys. Zinc can cause metal fume fever, commonly called "zinc chills" or "galo". The symptoms usually occur a few hours after exposure and include metallic taste in the mouth, dryness of nose and throat, weakness, fatigue, muscle and joint pains, fever, chills, and nausea.

MEDICAL PRECAUTIONARY MEASURES

1. Pre-employment medical examinations are recommended to insure that prospective employees are physically able to do the specific work. Periodic health examinations are recommended. The potential health effects of non-work related factors, such as smoking, must be considered.
2. An effective educational, training, and industrial hygiene program should be instituted. The program should cover the following: (a) the nature and potential hazards of welding and cutting; (b) proper and safe use of equipment; and (c) emergency and first aid procedures.
3. Medical personnel should be available on-site or by phone for advice and consultation. Emergency phone numbers should be posted near the telephones. At least one person on each shift should be trained in first aid, as well as qualified to administer oxygen and cardiopulmonary resuscitation (CPR).
4. The following should be readily available: (a) first aid supplies approved by a physician; (b) stretchers and blankets for transportation; (c) oxygen inhalation equipment; and (d) instant acting eye washes and showers.

5. Good personal hygiene practices are very important. Employees should wash their face and hands before eating, and it is recommended they not be permitted to eat, drink, or smoke in the work area. Food and beverages should not be stored in the work area. Contaminated clothing should be changed.
6. Protection against skin conditions, such as chemical burns, rashes, and dermatitis can be provided by appropriate protective clothing and equipment, as well as the use of protective creams or lotions.
7. All employees should be protected from ultraviolet rays. Noncombustible or flame proof screens or shields, appropriate eye protection, and other protective equipment should be used.
8. Respirators may be needed where engineering and administrative controls do not provide adequate protection. If respirators are used, they should be approved by NIOSH, MSHA or other approving agency.
9. Emergency and first aid procedures are given on the back cover of this booklet.

Threshold limit values (TLV) for materials may be found in the American Conference of Governmental Industrial Hygienists publication entitled "Thresh-old Limit Values for Chemical Substances and Physical Agents in the Workroom Environment," (published annually). A selection of typical values for a variety of materials used in welding and cutting is listed in Table 2, which summarizes some of the health hazards which may be found in the welding environment. (These values are subject to change; therefore, refer to its latest publication.)

HEALTH HAZARDS REFERENCES

Some authoritative sources on health hazard effects include the following:

1. "Guide to Occupational Exposure Values" (latest edition), American Conference of Governmental Industrial Hygienists, 1330 Kemper Meadow Dr., Cincinnati, OH 45240-4148 (www.acgih.org)
2. "AWS Fumes and Gases in the Welding Environment" (1979), American Welding Society, 550 N.W. LaJeune Rd., Miami, FL 33126 (www.acs.org)
3. "Encyclopedia of Occupational Health and Safety", Vols. I & II, J. M. Stellman, Fourth Edition (1998), International Labour Office, Geneva, Switzerland (www.ilo.org/public/english/protection/safework/cis/products/dbs.htm)
4. "Patty's Industrial Hygiene and Toxicology", Fifth Edition (2000), John Wiley & Sons, New York
5. "Safety & Health in Arc Welding and Gas Welding & Cutting", NIOSH Publication No. 78-138, (1978) U.S. Department of Health, Education and Welfare, Public Health Service, Center for Disease Control, Superintendent of Documents, U.S. Government Printing Office, Washington, D.C. 20402 (www.ntis.gov/search/index.aspx Use Product Code: PB83174920)
6. "Dangerous Properties of Industrial Materials", N. Irving Sax, Eleventh Edition (2004), John Wiley & Son. New York
7. "Documentation of the Threshold Limit Values for Substances and Biological Exposure Indices With Other Worldwide Occupational Exposure Values", (latest edition), American Conference of Governmental Industrial Hygienists, 1330 Kemper Meadow Dr., Cincinnati, OH 45240-4148 (www.acgih.org)

Chemical Substance	(1) TLV-TWA	OSHA PELs-TWA	Potential Health Hazard
Aluminum, Metal and insoluble compounds	^(b) 1 mg/m ³ R	15 mg/m ³ (Total dust) 5 mg/m ³ (Respirable fraction)	Acute: Irritant to eyes, skin, and respiratory tract. Chronic: Unknown-possible pneumoconiosis. Possible neurological effects.
Aluminum, Welding fumes, as Al	-----	5 mg/m ³ (NIOSH REL)	
Antimony & compounds, as Sb	0.5 mg/m ³	0.5 mg/m ³	Acute: Skin and upper respiratory tract irritation. Chronic: Animal carcinogen via inhalation.
Arsenic & inorganic compounds, (except arsine), as As	0.01 mg/m ³	0.5 mg/m ³ (Organic compounds) 0.01 mg/m ³ (Inorganic compounds)	Acute: Irritation of skin and mucous membranes. Chronic: Carcinogenic.
Asbestos, All forms	^(b) 0.1 f/cc (F)	0.1 f/cc ^(a) C 1 f/cc (30 min.)	Chronic: Fibrosis of lungs and reduced lung function; Carcinogenic.
Barium and soluble compounds, as Ba	0.5 mg/m ³	0.5 mg/m ³	Acute: Irritant to eyes, skin, and respiratory tract. Chronic: Muscular stimulation.
Beryllium and compounds, as Be	^(a) 0.00005 mg/m ³ I	0.002 mg/m ³ ^(b) C 0.005 mg/m ³	Acute: Lung inflammation which may be fatal. Chronic: Pneumonitis which may be fatal. Suspected human carcinogen. Chronic beryllium disease.
Cadmium and compounds, as Cd	0.01 mg/m ³ ^(b) 0.002 mg/m ³ R	0.005 mg/m ³	Acute: Lung edema which may be fatal. Chronic: Kidney and lung damage. May have latent interval and be progressive. Carcinogenic.
Carbon Black	3.5 mg/m ³	3.5 mg/m ³	No demonstrated health hazard. Chronic: Animal carcinogen although no human evidence.
Carbon Dioxide	5,000 ppm	5,000 ppm	Acute: Mild to severe asphyxia. Toxic in high concentrations.
Carbon Monoxide	25 ppm	50 ppm	Acute: Mild to severe asphyxia. Can be fatal if inhaled causing carboxyhemoglobin formation. Chronic: None known.
Chlorinated Hydrocarbon Solvent	See "Health Hazards References" 1, for specific compound.	See "Health Hazards References" 1, for specific compound.	Acute: Narcotic. Chronic: Liver & kidney damage.
Chromium metal	0.5 mg/m ³	1 mg/m ³	Acute: Allergen to skin. Irritant to skin, eyes, mucous membranes and lungs. Nose bleeds, ulceration and perforation of nasal septum. Chronic: Carcinogenic.
Chromium inorganic compounds, as Cr Hexavalent, water soluble	0.05 mg/m ³ , as Cr 0.01 mg/m ³ , as Cr	0.005 mg/m ³ , as Cr(VI) 0.005 mg/m ³ , as Cr(VI)	
Chromium inorganic compounds, as Cr Trivalent	0.5 mg/m ³	0.5 mg/m ³	

Chemical Substance	(1) TLV-TWA	OSHA PELs-TWA	Potential Health Hazard
Cobalt and inorganic compounds, as Co	0.02 mg/m ³	0.1 mg/m ³ (Metal dust & fume, as Co)	Acute: Allergic dermatitis and asthma. Chronic: Lung inflammation, heart effects (myocardial)
Copper, Fume, as Cu	0.2 mg/m ³	0.1 mg/m ³	Acute: Irritant to eyes, skin, and mucous membranes. Metal fume fever. Chronic: Only in those with Wilson's disease.
Fluorides, as F	2.5 mg/m ³	2.5 mg/m ³	Acute: Irritation of skin and mucous membranes. Increased bone density.
Iron Oxide (Fe ₂ O ₃)	⁽³⁾ 5 mg/m ³ R	10 mg/m ³ (Fume)	Chronic: Bone damage, fluorosis. Acute: Metal fume fever. Chronic: Benign pneumoconiosis.
Lead and inorganic compounds	0.05 mg/m ³ , as Pb	0.05mg/m ³ See 29 CFR 1910.1025	Acute: Systemic lead poisoning. Chronic: Neurological and blood effects. Animal carcinogen. May also affect the reproductive system.
Manganese and inorganic compounds, as Mn	0.2 mg/m ³ ⁽⁶⁾ ⁽²⁾ NIC-0.02 mg/m ³ R ⁽⁶⁾ ⁽⁴⁾ NIC-0.2 mg/m ³ I ⁽⁷⁾ NIC-A4	⁽⁵⁾ C 5 mg/m ³	Acute: Minor irritant. Chronic: Irreversible damage to the central nervous system, including the brain, symptoms of which may include slurred speech, lethargy, tremor, muscular weakness, psychological disturbances and spastic gait.
Manganese, Fume, as Mn	0.2 mg/m ³	⁽⁵⁾ C 5 mg/m ³	
Mercury, inorganic compounds, as Hg	0.025 mg/m ³	⁽⁶⁾ C 0.1 mg/m ³	Acute: Injury to respiratory, digestive, renal, and cardiovascular system. May be fatal. Chronic: Damage to central nervous system, gastro intestinal, renal, respiratory system, and skin.
Molybdenum	⁽⁴⁾ 10 mg/m ³ I ⁽²⁾ 3 mg/m ³ R	15 mg/m ³ (Total dust)	Acute: Mild irritant to mucous membranes. Chronic: Lower respiratory tract irritation.
Soluble compounds, as Mo	⁽²⁾ 0.5 mg/m ³ R	5 mg/m ³	
Nickel, inorganic compounds	⁽⁴⁾ 0.2 mg/m ³ I ⁽⁴⁾ 0.1 mg/m ³ I	1 mg/m ³ 1 mg/m ³	Local: Skin sensitizer. Systemic: Suspect carcinogen.
Soluble compounds, as Ni	⁽⁴⁾ 0.2 mg/m ³ I ⁽⁴⁾ 0.1 mg/m ³ I	⁽⁶⁾ C 5 ppm	Acute: Severe irritant to eyes and mucous membranes. Difficulty in breathing. Chronic: Lung dysfunction.
Nitrogen Dioxide	3 ppm		

Chemical Substance

(1) TLV-TWA

OSHA PELs-TWA

Potential Health Hazard

Ozone	0.05 ppm (Heavy Work) 0.1 ppm (Light Work)	0.2 mg/m ³	Acute: Severe irritant to eyes and mucous membranes. Difficulty in breathing. Chronic: Lung fibrosis.
Phosgene	0.4 mg/m ³ (0.1 ppm)	0.4 mg/m ³ (0.1 ppm)	Acute: Lung damage may be fatal. Fibrosis and lung damage.
Phosphine	0.42 mg/m ³ (0.3 ppm)	0.4 mg/m ³ (0.3 ppm)	Acute: Irritation of lungs, liver damage, and central nervous system (CNS) depression. CNS impairment.
Sodium Fluoride-see Fluorides	2.5 mg/m ³ (as F)	2.5 mg/m ³ (as F)	Acute: Irritant to eyes, skin, mucous membranes, and lungs. Chronic: Nose bleeds and sinusitis.
Silica (Silicon Dioxide) – Crystalline, alpha-Quartz	⁽²⁾ 0.025 mg/m ³ R	Use "Quartz" formulas in "Health Hazards References" 1.	Chronic: Can cause silicosis and may cause cancer. Pulmonary fibrosis.
Titanium Dioxide	10 mg/m ³	15 mg/m ³ (Total dust)	Acute: Combined with chlorine, lung injury can occur. Chronic: Possibly carcinogenic (animal carcinogen).
Welding fumes (Not otherwise specified)	Withdrawn. (Previously 5 mg/m ³)	-----	Acute: Respiratory irritation. Chronic: Possible human carcinogen.
Zinc Oxide, Fume	-----	5 mg/m ³	Acute: Irritant to skin. Metal fume fever.
Zinc Oxide	⁽²⁾ 2 mg/m ³ R	15 mg/m ³ (Total dust) 5 mg/m ³ (Respirable fraction)	

(1) Threshold Limit Values-Time Weighted Average (2009 ACGIH Guide to Occupational Exposure Limits)

(2) "R" - Measured as respirable fraction of the aerosol.

(3) "(F)" - Respirable fibers: length > 5µ, aspect ratio > or = 3:1, as determined by the membrane filter method at 400-450x magnification (4-mm objective), using phase-contrast illumination.

(4) "I" - Measured as inhalable fraction of the aerosol.

(5) "C" - Threshold Limit Ceiling Value - The concentration that should not be exceeded even instantaneously.

(6) "NIC" - Notice of Intended Change

(7) "NIC-A4" - Notice of Intended Change-Not Classifiable as a Human Carcinogen

RECOMMENDED REFERENCES

The following nationally recognized publications on safety in welding and cutting operations are recommended to the reader. These publications have been prepared for the protection of persons from injury and illness and the protection of property from damage by fire and other causes arising from welding and cutting.

- A. Publications available from the American Welding Society, P.O. Box 351040, Miami, FL 33135;
 - 1. "Welding Safety and Health Information Packet" - SHP
 - 2. "Safety in Welding and Cutting" - ANSI Z49.1.
 - 3. "Recommended Safe Practices for the Preparation for Welding and Cutting of Containers and Piping That Have Held Hazardous Substances" - AWS F4.1.
 - 4. "Method for Sampling Airborne Particulates Generated by Welding and Allied Processes" - ANSI AWS F1.1.
 - 5. "Fumes and Gases in the Welding Environment, 1979".
 - 6. "Effects of Welding on Health" - EWH.
 - 7. "Operator's Manual for Oxy Fuel Gas Cutting" - AWS C4.2
 - 8. "Safety and Health Fact Sheets" - SHF

- B. Publications available from the National Fire Protection Association, Batterymarch Park, P.O. Box 9101, Quincy, MA 02269
 - 1. "Cutting and Welding Processes" - NFPA 51 B.
 - 2. "Oxygen-Fuel Gas Systems for Welding, Cutting and Allied Processes" - NFPA 51.
 - 3. "Standard for Oxygen Systems at Consumer Sites" - NFPA No. 50.
 - 4. "Storage and Handling of Liquefied Petroleum Gases" - NFPA No. 58.
 - 5. "National Electrical Code" - NFPA 70.

- C. Publications available from the Compressed Gas Association Inc., 1235 Jefferson Davis Highway, Arlington, VA 22202.
 - 1. "Safe Handling of Compressed Gases in Cylinders" — CGA P-1.
 - 2. "Compressed Gas Cylinder Valve Outlet and Inlet Connections" — CGA V-1.
 - 3. "Specifications for Rubber Welding Hose."
 - 4. "Acetylene," Pamphlet G-1.
 - 5. "Oxygen," Pamphlet G-4.
 - 6. "Handbook of Compressed Gases."

- D. Publications available from your products supplier or from ESAB Welding and Cutting Products, P.O. Box 100545, Florence, SC 29501-0545.
1. "Precautions and Safe Practices for Arc Welding, Cutting and Gouging," Form 52-529.
 2. Material Safety Data Sheets for various products.
 3. The Oxy-Acetylene Handbook" - P/N 781 F00.
- E. Other Publications:
1. "Safe Practices for Occupation and Educational Eye and Face Protection" - ANSI Z87.1, American National Standards Institute, 1430 Broadway, New York, NY 10018.
 2. "Occupational Safety and Health Standards" - 29 CFR 1910, U.S. Department of Labor, Occupational Safety and Health Administration, Superintendent of Documents, U.S. Government Printing Office, Washington, D.C. 29402.

EMERGENCY AND FIRST-AID PROCEDURES

First aid is immediate, temporary treatment given in the event of accident or illness. Immediate first aid (within four minutes) may be the difference between complete recovery, permanent impairment, or death.

INHALATION — Workers with symptoms of exposure to fumes and gases should go to an uncontaminated area and inhale fresh air or oxygen. If unconscious, immediately remove to an uncontaminated area and call a physician. Administer oxygen by mask if the person is breathing. If breathing has stopped, administer cardiopulmonary resuscitation (CPR), preferably with simultaneous administration of oxygen. Keep the victim warm and at rest.

EYE - Contact lenses, if worn, should be removed. Irrigate the eyes immediately with large amounts of water for 15 minutes. Occasionally hold the eyelids apart to insure complete irrigation. Apply a dry protective dressing. Call for emergency medical assistance.

Don't remove dust from the eyes yourself. Get medical assistance.

For arc welding "Flash burns" cover the eye with cold (preferably iced) compresses for 5 to 10 minutes; then repeat. Apply a dry protective dressing. Call for emergency medical assistance. Don't rub the eye. Don't use ointments or drops unless prescribed by a physician.

SKIN — For skin contact with irritants, flush the areas with large amounts of water, and then wash with soap and water. Remove contaminated clothing. If mucous membranes are irritated, flush with water. Wash cuts and scrapes with mild soap and water. Avoid contamination. Apply a dry sterile dressing.

For thermal burns, cold water is an effective first aid measure. If skin is not broken, immerse burn part in clean cold water or apply clean ice to relieve pain. Do not disturb or open blisters. Prevent contamination. Bandage loosely with a clean dry dressing. Call for emergency medical assistance.

ELECTRICAL SHOCK AND ELECTRICAL BURNS — Disconnect and turn off power. Remove victim from contact. Use nonconducting materials if the rescuer must resort to pulling the victim from the live contact. Rescuers must first protect themselves by use of insulated materials such as gloves. If the victim is not breathing, administer CPR as soon as contact is broken. Call for emergency medical assistance. Continue CPR until spontaneous breathing has been restored or until a physician arrives. Administer oxygen. Keep comfortably warm. Keep horizontal until there is no further evidence of shock. Treat electrical burns as thermal burns. For electrical burns apply clean, cold (iced) compresses. Prevent contamination. Cover with a clean dry dressing. Call for emergency medical assistance.

OXWELD® / PUROX® / PREST-O-LITE®



ESAB Welding &
Cutting Products